

Robert H. Wager Co., Inc.

570 Montroyal Road
 Rural Hall, NC 27045
 Ph: 800-562-7024
 Fx: 336-969-6375
 www.wagerusa.com

For Reference Only
 Do Not Use For Engineering Purposes

1500 Series - Vent Outlet Closing Device

When Ordering, Please Specify:
 Body Material and Connection

Body Materials:
 Galvanized Steel (1020) ASTM-A-29
 Stainless Steel (304)(BY ORDER) & (316)(STANDARD) ASTM-A-351
 Aluminum (835)

Connections:
 Flanged (ANSI B16.5 - Standard)(all sizes)
 Std. cut groove for Victaulic S/07 coupling(all sizes)
 Buttweld (all sizes)
 Threaded (all sizes)

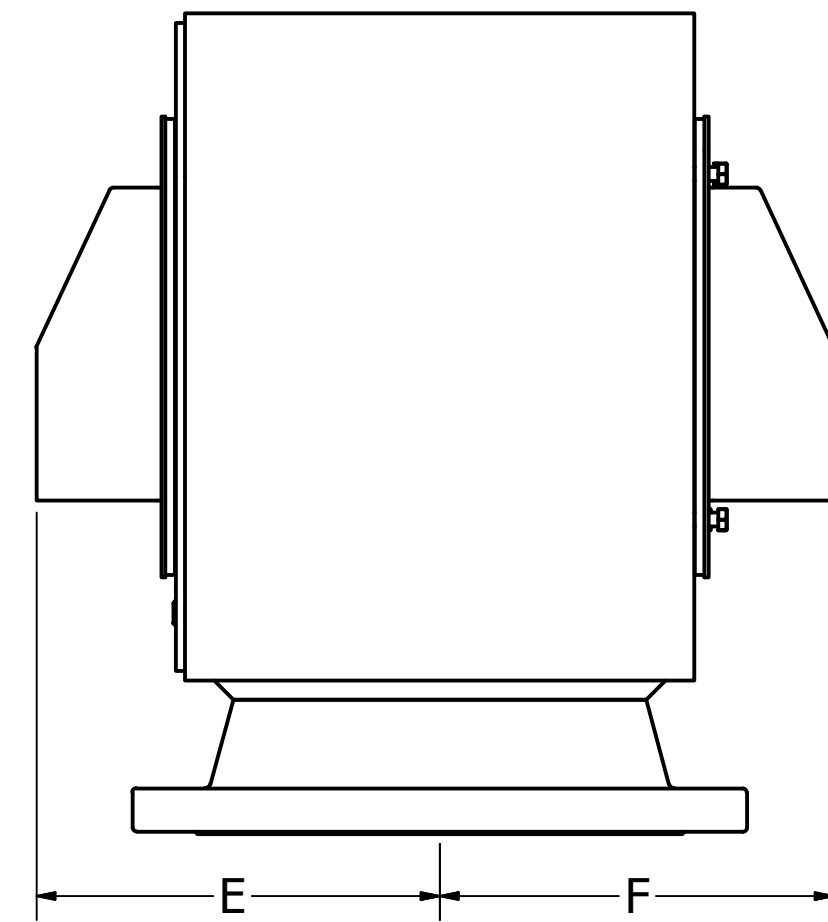
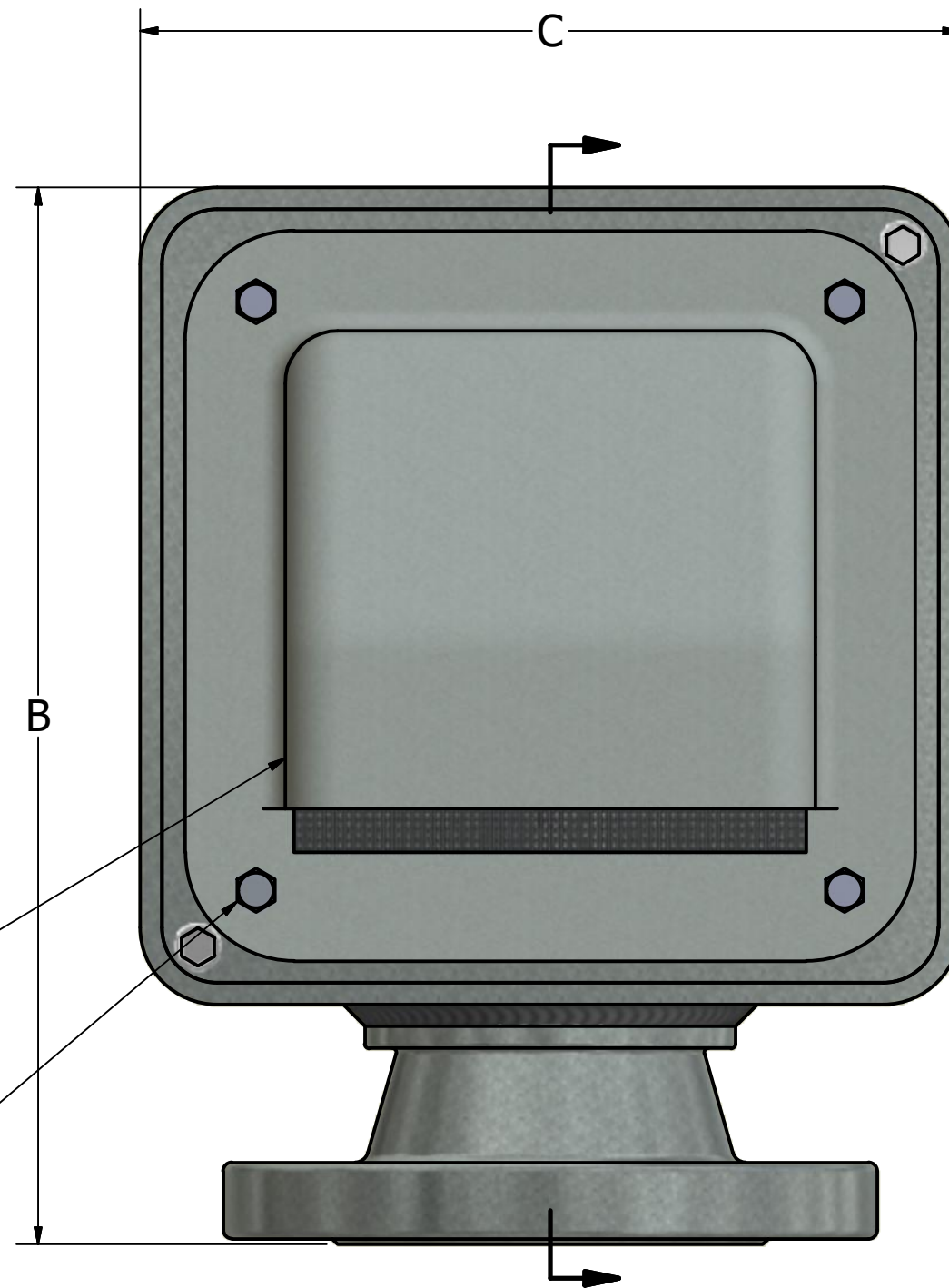
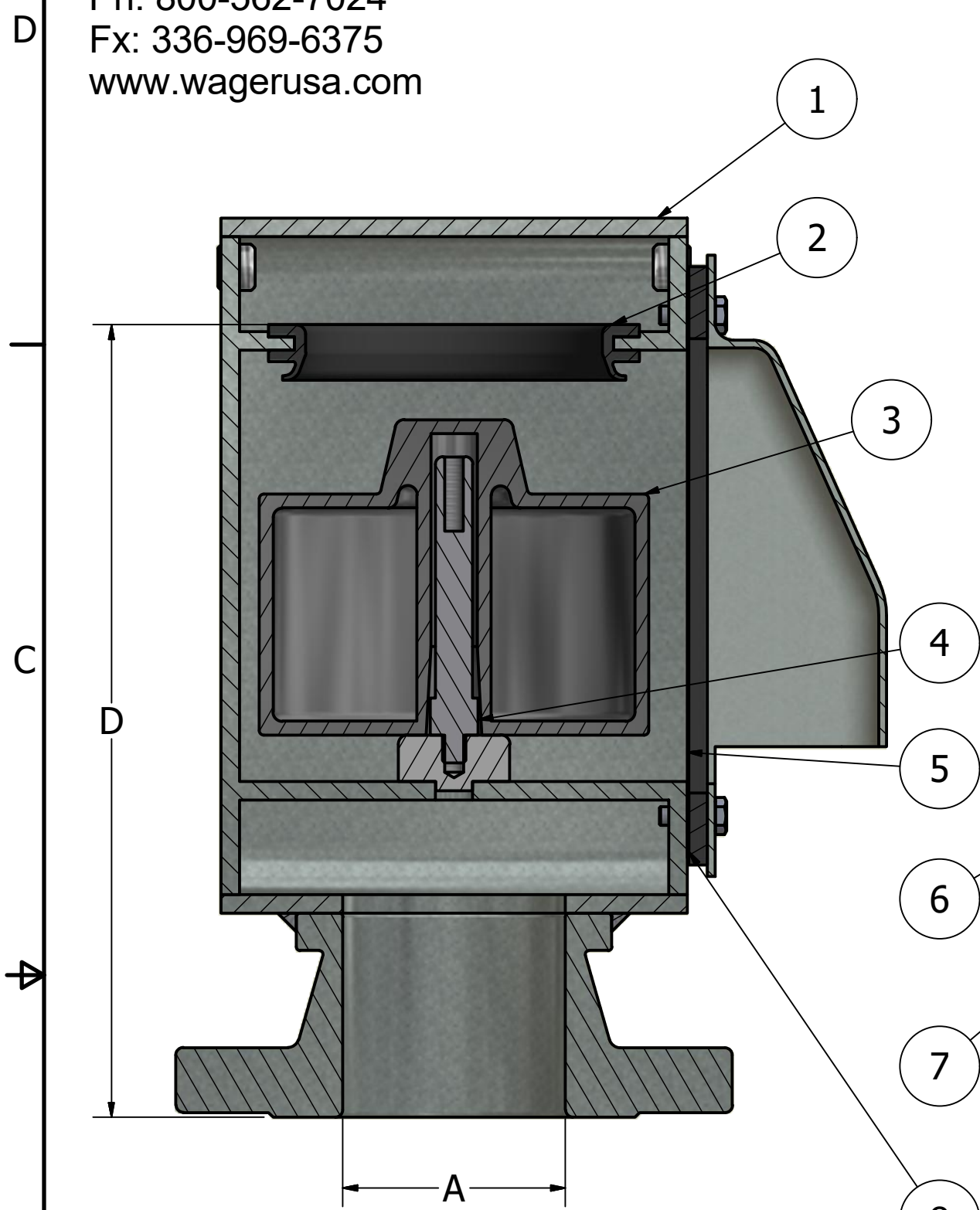

1500-10 (DOUBLE COVER)
 1500-12 (DOUBLE COVER)
 1500-14 (DOUBLE COVER)
 1500-16 (DOUBLE COVER)

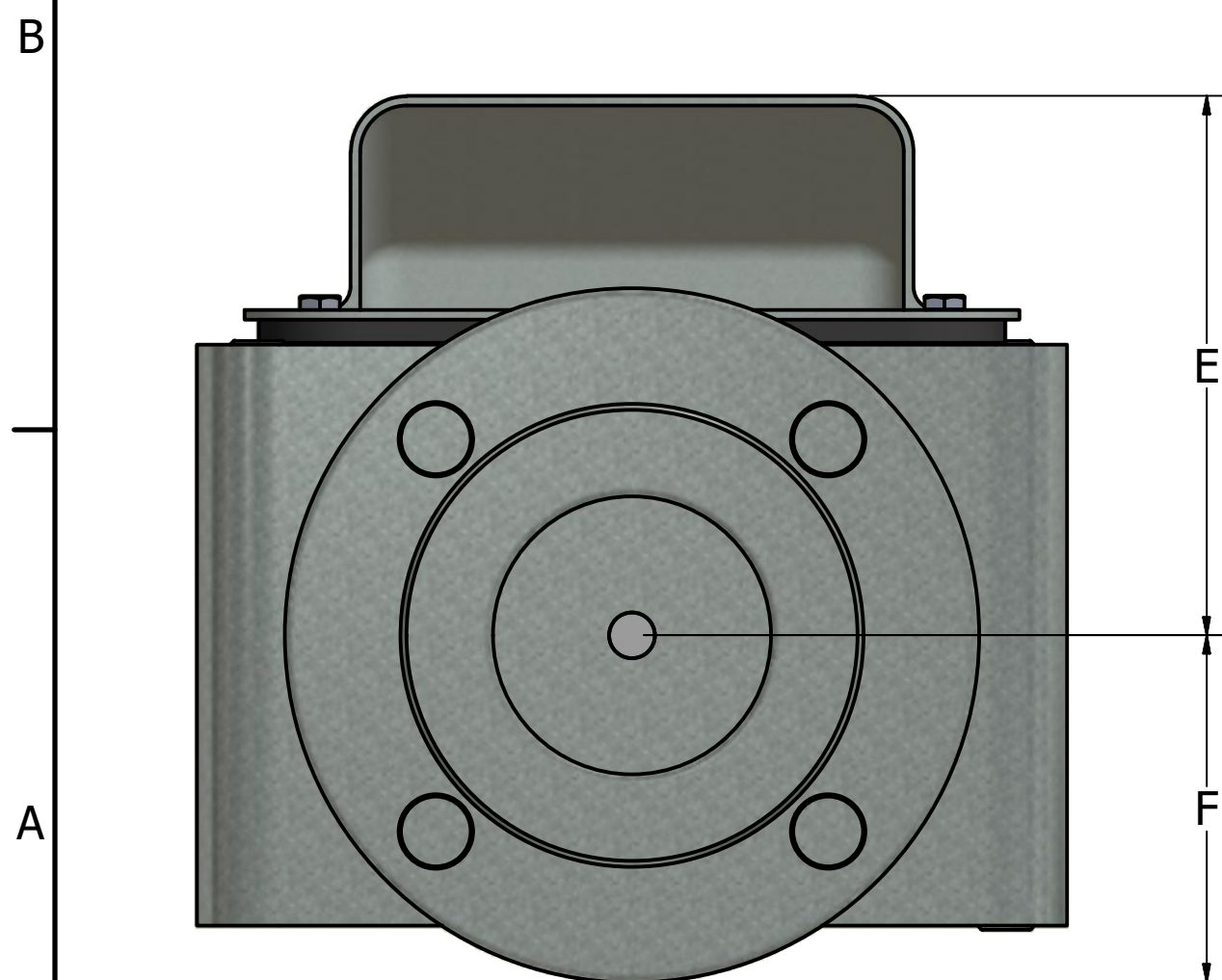

Parts List		
ITEM	NAME OF PART	QTY
1	Valve Housing	1
2	Seat	1
3	Float Disc	1
4	Guide Rod	1
5	Flame/Bug Screen 316SS	1
6	Cover	1
7	Cover Bolt	4
8	Cover Gasket	1

* 1.5"-8" HAVE 1 COVER AND GASKET
 10"-16" HAVE 2 COVERS AND GASKETS

DN SIZE Column 1	STANDARD SIZES IN INCHES						WEIGHT
	A	B	C	D	E	F	
40	1.5	10	7 1/2	9	4 3/8	2 7/8	22
50	2	10 3/4	7 1/2	9 1/2	4 3/8	3	23
65	2.5	10 3/4	7 1/2	9 1/2	4 3/8	3 1/2	25
80	3	12 1/8	9 1/2	10 3/4	5 7/8	3 3/4	39
100	4	12 3/8	9 1/2	10 7/8	5 7/8	4 1/2	43
125	5	15	11 1/2	13 1/8	7	5	75
150	6	17 1/2	14	15 1/2	8 1/4	5 1/2	110
200	8	21	17	18 1/2	10 5/8	6 3/4	170
250	10	21 5/8	22 3/8	17 5/8	10 1/8	10 1/8	210
300	12	29	26 1/2	24 1/2	13 7/8	13 7/8	400
350	14	29 1/4	26 1/2	24 1/2	13 7/8	13 7/8	415
400	16	30 1/4	32 1/4	25 1/2	14 3/4	14 3/4	550